

SELV

IP65

IP67



c



■ Features

- Universal AC input / Full range (up to 305VAC)
- Built-in active PFC function
- No load power consumption <0.5W at remote OFF
- High efficiency up to 96%
- -40°C ~ +70°C wide operating range
- Protections: Short circuit / Over current / Over voltage / Over temperature
- Fanless design, cooling by free air convection
- IP67 / IP65 design for indoor or outdoor installations
- Withstand 5G vibration test
- Three in one dimming function (0~10Vdc or PWM signal or resistance)
- Suitable for dry / damp / wet location
- 5 years warranty (Note.10)

■ Applications

- LED street lighting
- LED high-bay lighting
- Parking space lighting
- LED searchlight
- LED fishing lamp

■ Description

HLG-600H series is a high performance dustproof and waterproof AC-to-DC LED power supply up to 600Watts. The fully-potted silicone and the aluminum case facilitate the heat dissipation. Above all, it delivers the efficiency up to 96% that tops the LED power supply field. Other features include the wide working temperature range between -40°C and +70°C, the fan-less design, the adjustable output voltage and current, the surge susceptibility up to 4KV (EN61000-4-5), low no-load power consumption (<0.5Watt) at remote OFF and workable for 277VAC input. These attributes all make HLG-600H the fit for the indoor/outdoor LED lighting application requiring remarkable reliability.

■ Model Encoding

HLG - 600H - 12 (A)

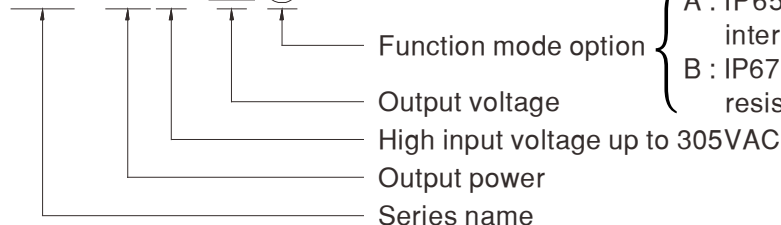

- A : IP65, Vo and Io level can be adjusted through internal potentiometer.
- B : IP67, Io adjustable with 0~10Vdc, PWM signal or resistance.



SPECIFICATION

MODEL		HLG-600H-12	HLG-600H-15	HLG-600H-20	HLG-600H-24	HLG-600H-30	HLG-600H-36	HLG-600H-42	HLG-600H-48	HLG-600H-54	
OUTPUT	DC VOLTAGE	12V	15V	20V	24V	30V	36V	42V	48V	54V	
	CONSTANT CURRENT REGION <small>Note.4</small>	6 ~ 12V	7.5 ~ 15V	10 ~ 20V	12 ~ 24V	15 ~ 30V	18 ~ 36V	21 ~ 42V	24 ~ 48V	27 ~ 54V	
	RATED CURRENT	40A	36A	28A	25A	20A	16.7A	14.3A	12.5A	11.2A	
	RATED POWER	480W	540W	560W	600W	600W	601.2W	600.6W	600W	604.8W	
	RIPPLE & NOISE (max.) <small>Note.2</small>	150mVp-p	150mVp-p	150mVp-p	150mVp-p	200mVp-p	250mVp-p	250mVp-p	250mVp-p	350mVp-p	
	VOLTAGE ADJ. RANGE <small>Note.6</small>	10.2 ~ 12.6V	12.7 ~ 15.8V	17 ~ 21V	20.4 ~ 25.2V	25.5 ~ 31.5V	30.6 ~ 37.8V	35.7 ~ 44.1V	40.8 ~ 50.4V	45.9 ~ 56.7V	
	CURRENT ADJ. RANGE	Can be adjusted by internal potentiometer A type only									
		20 ~ 40A	18 ~ 36A	14 ~ 28A	12.5 ~ 25A	10 ~ 20A	8.3 ~ 16.7A	7.1 ~ 14.3A	6.2 ~ 12.5A	5.6 ~ 11.2A	
	VOLTAGE TOLERANCE <small>Note.3</small>	±3.0%	±2.0%	±1.5%	±1.0%	±1.0%	±1.0%	±1.0%	±1.0%	±1.0%	
	LINE REGULATION	±0.5%	±0.5%	±0.5%	±0.5%	±0.5%	±0.5%	±0.5%	±0.5%	±0.5%	
	LOAD REGULATION	±2.0%	±1.5%	±1.0%	±0.5%	±0.5%	±0.5%	±0.5%	±0.5%	±0.5%	
	SETUP, RISE TIME <small>Note.8</small>	500ms, 80ms at full load 230VAC /115VAC									
HOLD UP TIME (Typ.)	15ms at full load 230VAC /115VAC										
INPUT	VOLTAGE RANGE <small>Note.5</small>	90 ~ 305VAC		127 ~ 431VDC							
	FREQUENCY RANGE	47 ~ 63Hz									
	POWER FACTOR (Typ.)	PF>0.98/115VAC, PF>0.95/230VAC, PF>0.93/277VAC at full load (Please refer to "Power Factor Characteristic" curve)									
	TOTAL HARMONIC DISTORTION	THD< 20% when output loading ≥ 50% at 115VAC/230VAC input and output loading ≥ 75% at 277VAC input									
	EFFICIENCY (Typ.)	230VAC	92%	93.5%	94.5%	95%	95%	95.5%	96%	96%	96%
		277VAC	92.5%	93.5%	94.5%	95%	95%	95.5%	96%	96%	96%
	AC CURRENT (Typ.)	7A / 115VAC		3.3A / 230VAC		2.9A / 277VAC					
	INRUSH CURRENT(Typ.)	COLD START 70A(twidth=1000μs measured at 50% Ipeak) at 230VAC									
LEAKAGE CURRENT	<0.75mA / 277VAC										
PROTECTION	OVER CURRENT <small>Note.4</small>	95 ~ 108%									
		Protection type : Constant current limiting, recovers automatically after fault condition is removed									
	SHORT CIRCUIT	Constant current limiting, recovers automatically after fault condition is removed									
	OVER VOLTAGE	13 ~ 16V	16.5 ~ 20.5V	22 ~ 26V	26 ~ 30V	32.5 ~ 36.5V	39.5 ~ 43.5V	46 ~ 50V	52.5 ~ 56.5V	59 ~ 63V	
	Protection type : Shut down o/p voltage, re-power on to recover										
OVER TEMPERATURE	Shut down o/p voltage, re-power on to recover										
FUNCTION	REMOTE ON/OFF CONTROL	Power on : "Hi" >2 ~ 5V or (Open circuit) Power off : "Low" <0 ~ 0.5V or (Short circuit)									
	5V STANDBY	5Vsb : 5V@0.5A ; tolerance ±5%, ripple : 100mVp-p(max.)									
ENVIRONMENT	WORKING TEMP.	-40 ~ +70°C (Refer to "Derating Curve")									
	WORKING HUMIDITY	20 ~ 95% RH non-condensing									
	STORAGE TEMP., HUMIDITY	-40 ~ +85°C, 10 ~ 95% RH									
	TEMP. COEFFICIENT	±0.03%/°C (0 ~ 60°C)									
	VIBRATION	10 ~ 500Hz, 5G 12min./1cycle, period for 72min. each along X, Y, Z axes									
SAFETY & EMC	SAFETY STANDARDS <small>Note.7</small>	UL8750, CSA C22.2 No. 250.13-12, EN61347-1, EN61347-2-13 independent, IP65 or IP67 approved									
	WITHSTAND VOLTAGE	I/P-O/P:3.75KVAC I/P-FG:2KVAC O/P-FG:0.5KVAC									
	ISOLATION RESISTANCE	I/P-O/P, I/P-FG, O/P-FG:100M Ohms / 500VDC / 25°C / 70% RH									
	EMC EMISSION	Compliance to EN55015, EN55022(CISPR22) Class B, EN61000-3-2 Class C (≥ 50% load) ; EN61000-3-3									
	EMC IMMUNITY	Compliance to EN61000-4-2,3,4,5,6,8,11, EN61547, EN55024, light industry level (surge 4KV), criteria A									
OTHERS	MTBF	76.9K hrs min. MIL-HDBK-217F (25°C)									
	DIMENSION	280*144*48.5mm (L*W*H)									
	PACKING	3.9Kg; 4pcs/16.6Kg/0.9CUFT									
NOTE	<ol style="list-style-type: none"> All parameters NOT specially mentioned are measured at 230VAC input, rated load and 25°C of ambient temperature. Ripple & noise are measured at 20MHz of bandwidth by using a 12" twisted pair-wire terminated with a 0.1uf & 47uf parallel capacitor. Tolerance : includes set up tolerance, line regulation and load regulation. Constant current operation region is within 50%~100% rated output voltage. This is the suitable operation region for LED related applications, but please reconfirm special electrical requirements for some specific system design. Derating may be needed under low input voltages. Please check the static characteristics for more details. A type only. Safety and EMC design refer to EN60598-1, subject CNS15233, GB7000.1, FCC part18. Length of set up time is measured at cold first start. Turning ON/OFF the power supply may lead to increase of the set up time. The power supply is considered as a component that will be operated in combination with final equipment. Since EMC performance will be affected by the complete installation, the final equipment manufacturers must re-qualify EMC Directive on the complete installation again. Refer to warranty statement 										

Block Diagram

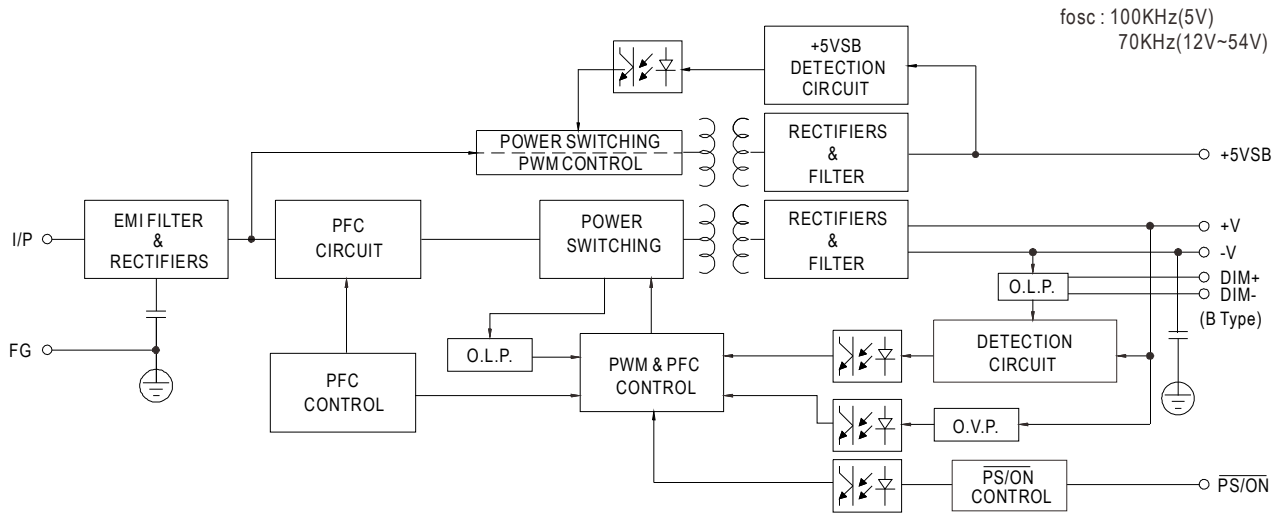

Derating Curve

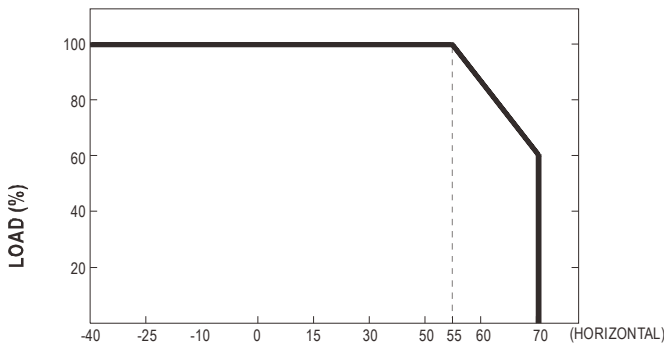

AMBIENT TEMPERATURE (°C)

Note : At high ambient temperature $T_a=70^{\circ}\text{C}$, if HLG-600H operates in C.C mode, the maximal current must not be greater than 60% of the rated current.

Static Characteristics

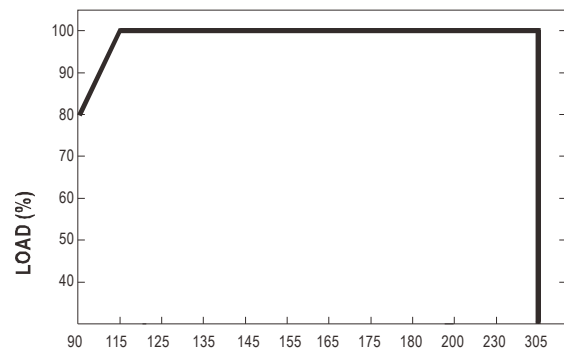

INPUT VOLTAGE (V) 60Hz

Power Factor Characteristic

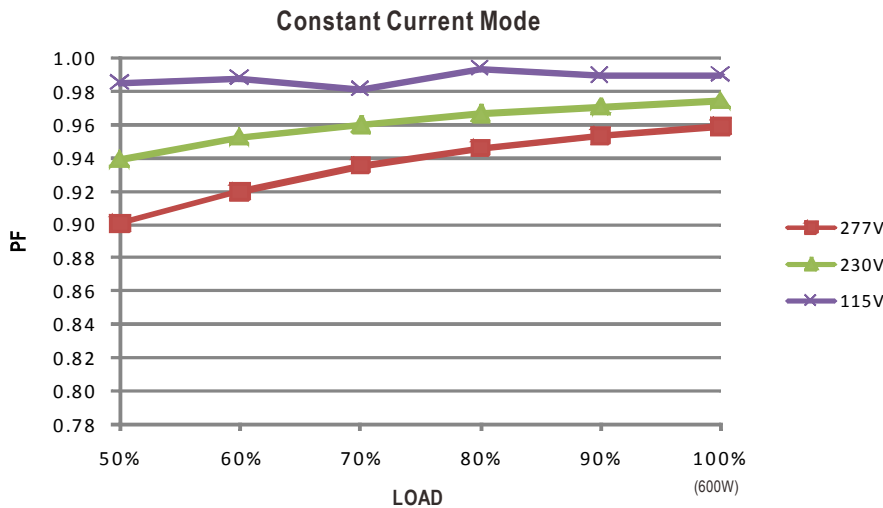

EFFICIENCY vs LOAD (54V Model)

HLG-600H series possess superior working efficiency that up to 96% can be reached in field applications.

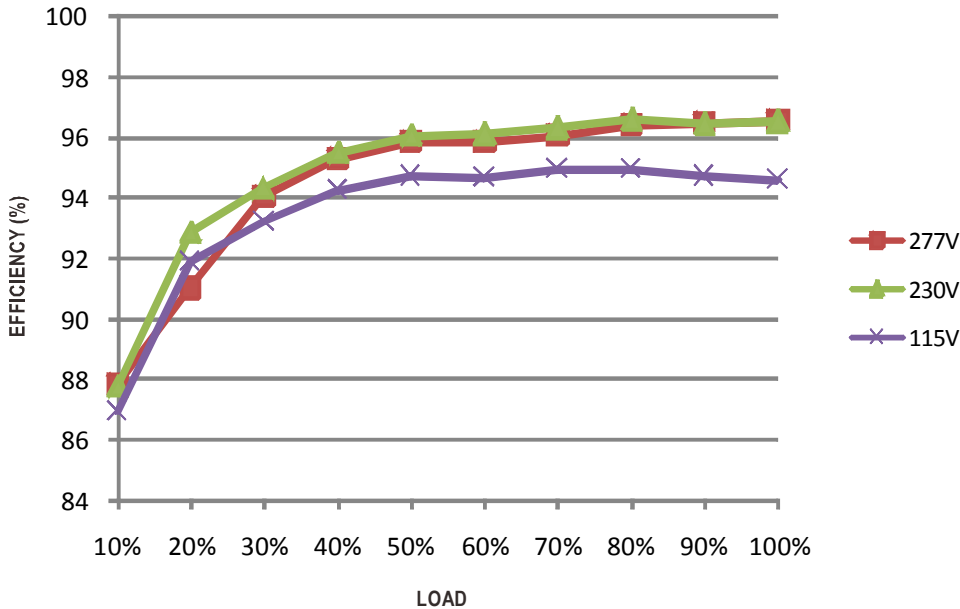

DRIVING METHODS OF LED MODULE

There are two major kinds of LED drive method "direct drive" and "with LED driver".

A typical LED power supply may either work in "constant voltage mode (CV) or constant current mode (CC)" to drive the LEDs.

Mean Well's LED power supply with CV+ CC characteristic can be operated at both CV mode (with LED driver, at area (A) and CC mode (direct drive, at area (B)).

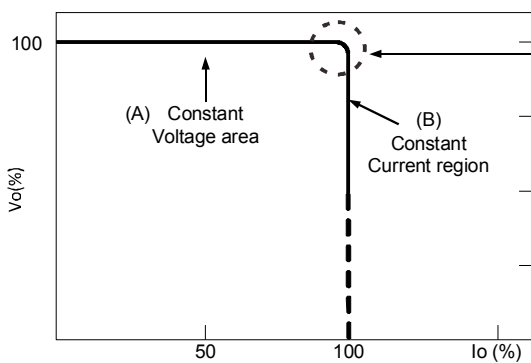

Typical LED power supply I-V curve

In the constant current region, the highest voltage at the output of the driver depends on the configuration of the end systems.

Should there be any compatibility issues, please contact MEAN WELL.

■ **DIMMING OPERATION (for B-type only)**

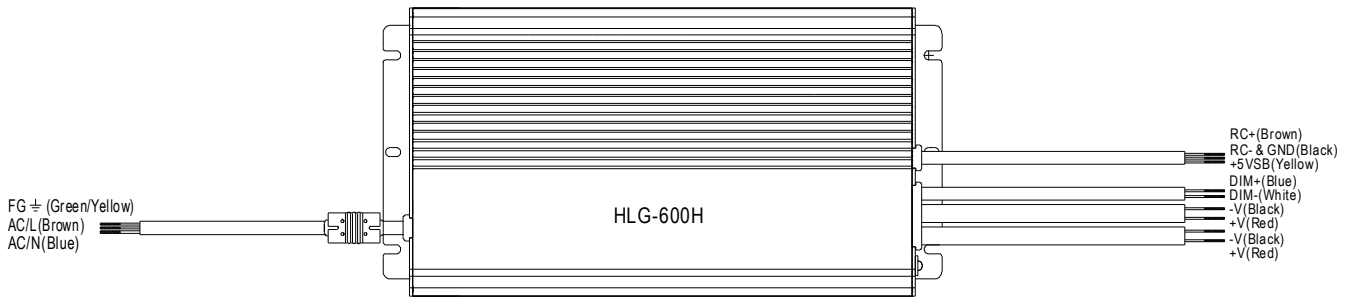

※ Built-in 3 in 1 dimming function, IP67 rated. Output constant current level can be adjusted through output cable by connecting a resistance or 0 ~ 10Vdc or 10V PWM signal between DIM+ and DIM-.

※ Please DO NOT connect "DIM-" to "-V".

※ Reference resistance value for output current adjustment (Typical)

Resistance value	Single driver	Short	10K Ω	20K Ω	30K Ω	40K Ω	50K Ω	60K Ω	70K Ω	80K Ω	90K Ω	100K Ω	OPEN
	Multiple drivers <small>(N=driver quantity for synchronized dimming operation)</small>	Short	10K Ω/N	20K Ω/N	30K Ω/N	40K Ω/N	50K Ω/N	60K Ω/N	70K Ω/N	80K Ω/N	90K Ω/N	100K Ω/N	-----
Percentage of rated current		0%	10%	20%	30%	40%	50%	60%	70%	80%	90%	100%	95%~108%

※ 0 ~ 10V dimming function for output current adjustment (Typical)

Dimming value	0V	1V	2V	3V	4V	5V	6V	7V	8V	9V	10V	OPEN
Percentage of rated current	0%	10%	20%	30%	40%	50%	60%	70%	80%	90%	100%	95%~108%

※ 10V PWM signal for output current adjustment (Typical): Frequency range :100Hz ~ 3KHz

Duty value	0%	10%	20%	30%	40%	50%	60%	70%	80%	90%	100%	OPEN
Percentage of rated current	0%	10%	20%	30%	40%	50%	60%	70%	80%	90%	100%	95%~108%

※ Direct connecting to LEDs is suggested, but is not suitable for using additional drivers.

Mechanical Specification

Case No. 228 Unit:mm

A Type:(HLG-600H-_A)

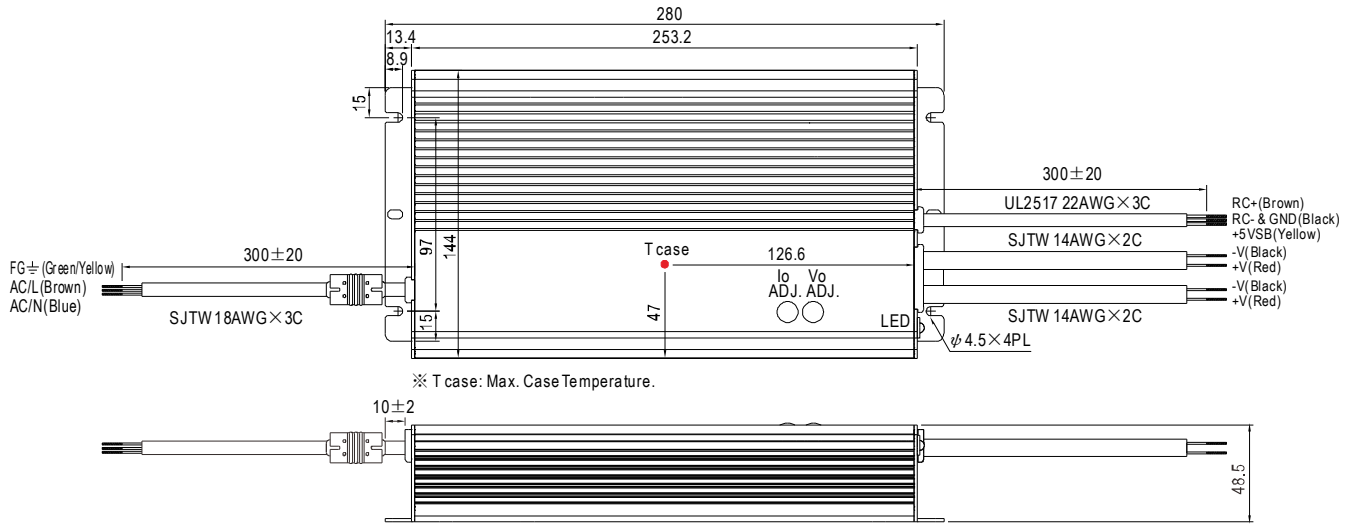

※ IP65 rated. Output voltage and constant current level can be adjusted through internal potentiometer.
(Can access by removing the rubber stopper on the case.)

B Type:(HLG-600H-_B)

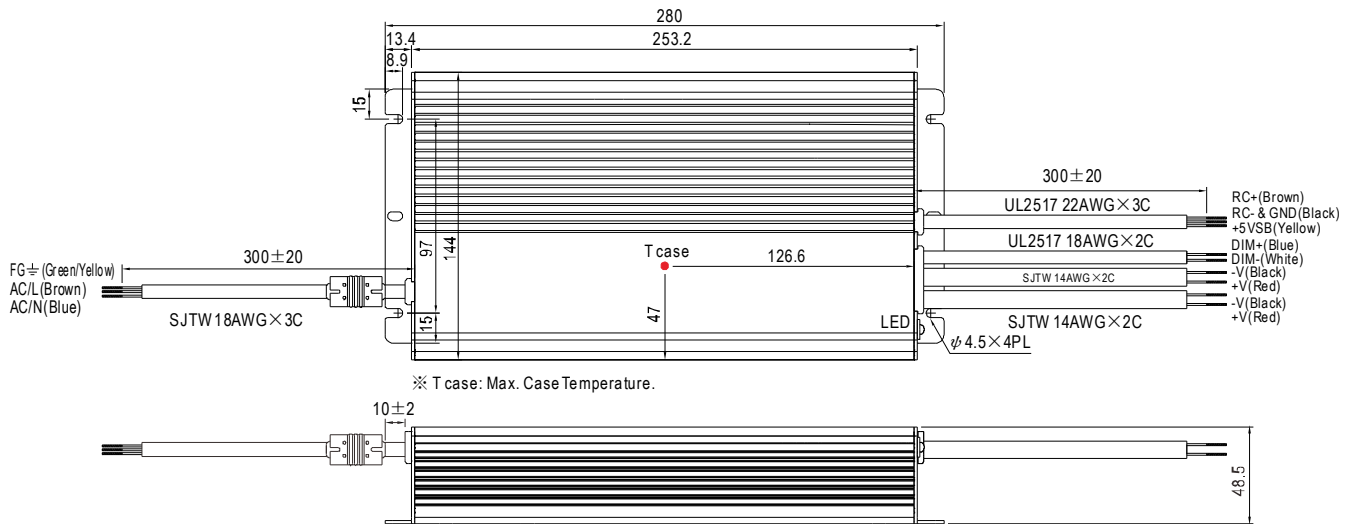

Installation Manual

Please refer to : <http://www.meanwell.com/webnet/search/InstallationSearch.html>